

THE MORNING AFTER
PRINT OUT – CUT OUT – GET OUT !

LET'S HAVE A LOOK AROUND!

The Top Bedroom

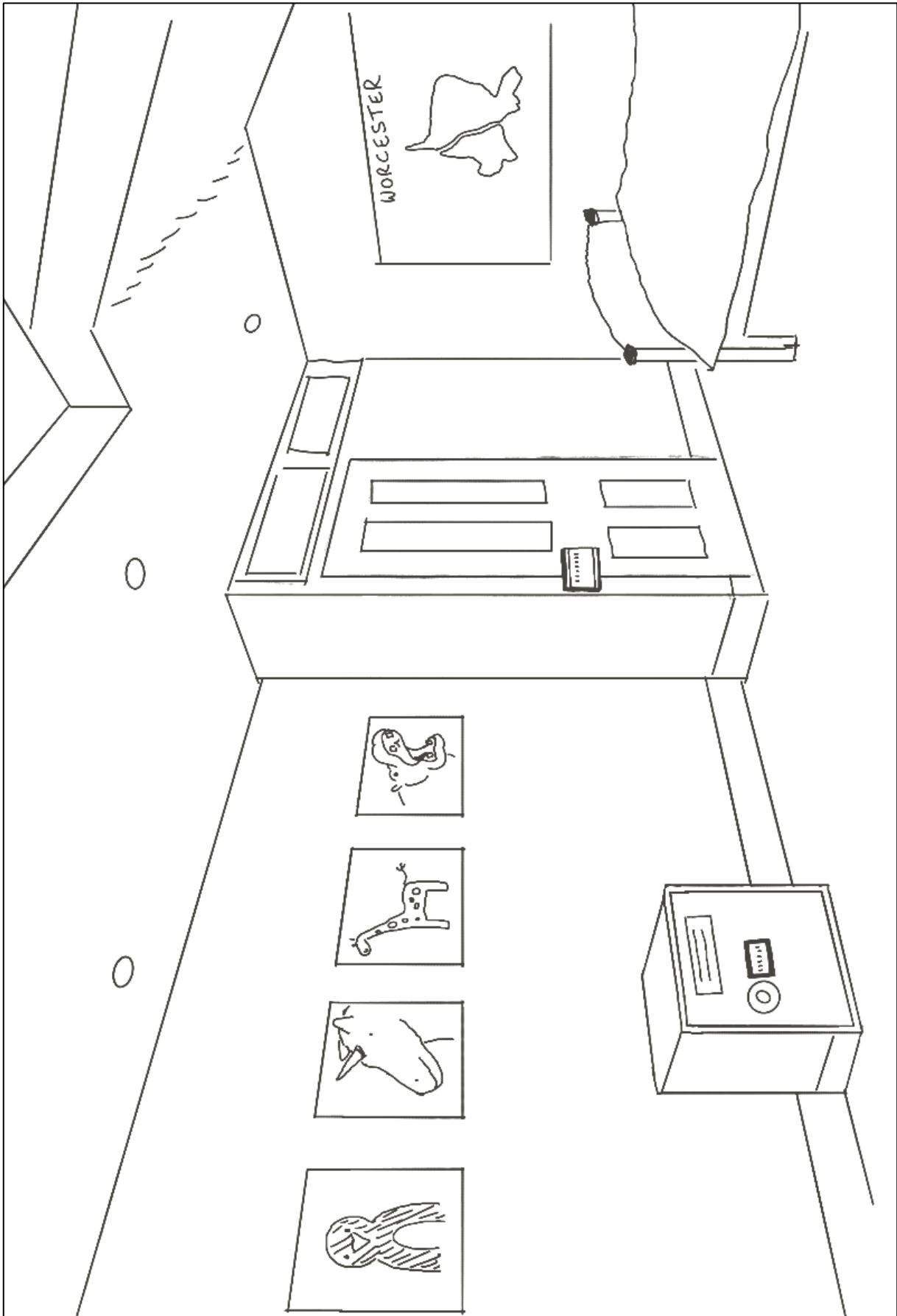

THE MORNING AFTER
PRINT OUT – CUT OUT – GET OUT !

LET'S HAVE A LOOK AROUND!

The Emergency Phone

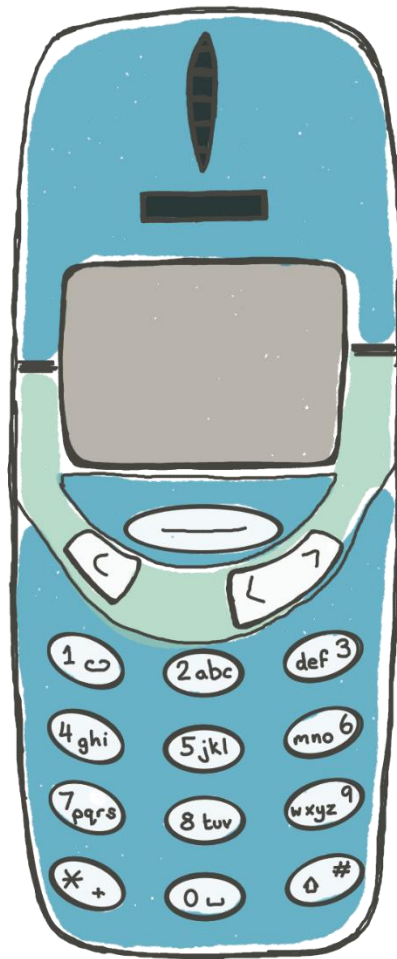

THE MORNING AFTER
PRINT OUT – CUT OUT – GET OUT !

LET'S HAVE A LOOK AROUND!

MAP OF WORCESTER ON THE WALL

WORCESTER

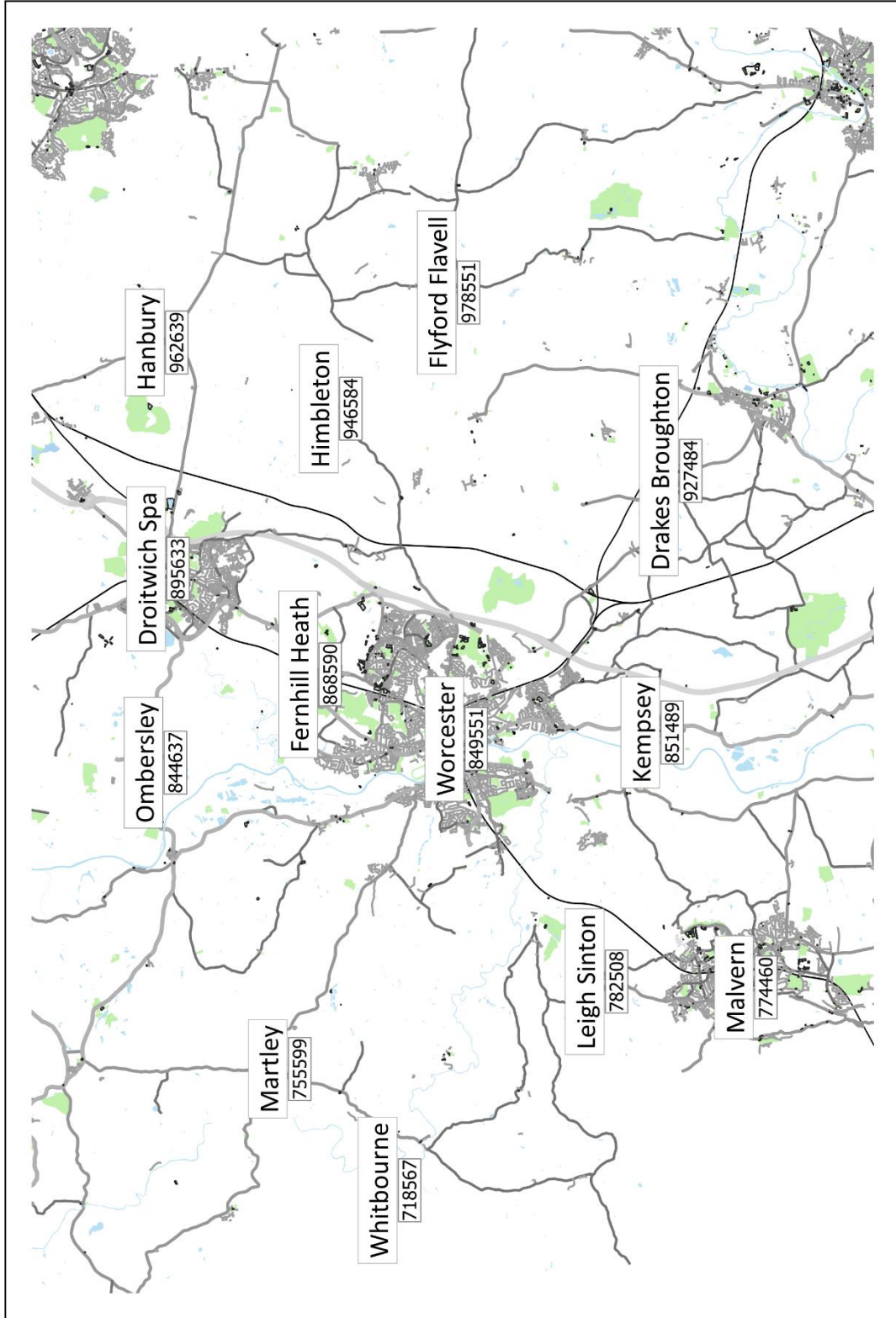

WE'RE IN!

Rob's Password Notebook

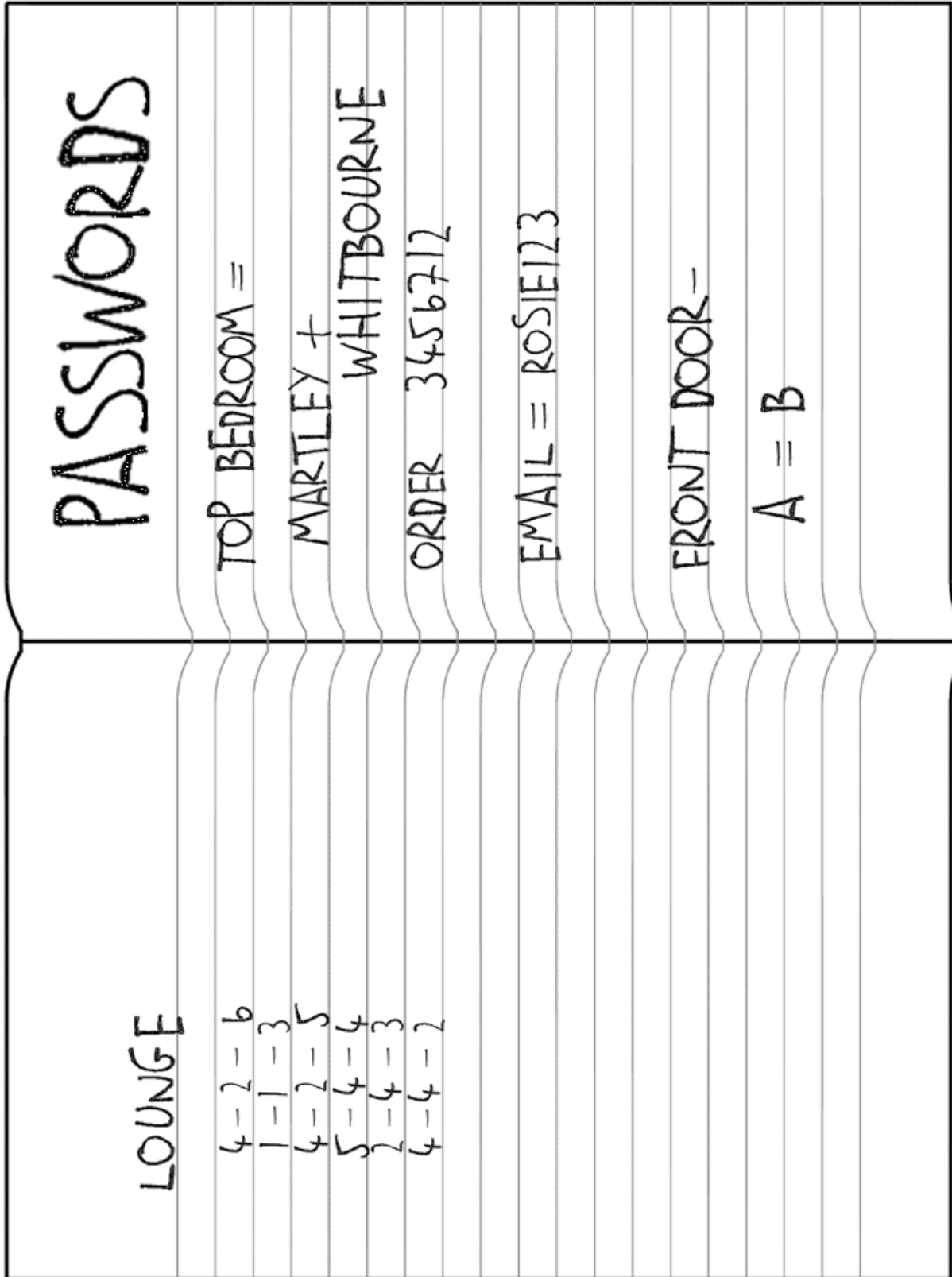

GUEST LIST

ME	ANDY	COLIN	ROB	NEIL	LIZZIE	LOUISE	MO
NELLY	JOE	RAY	PAT	CHLOE	JAMES	KEVIN	TONY
PAT	SINEAD	BEV	OLLIE	PIXIE	BEV	DAN	SAM
JANE	JAN	COLIN	FRAN	ADRIAN	SIMON	FIONA	STU
STU	BEN	GAR		DAVINA	NICK	FATZ	DAVE
EMILY	SEEKHA	TASH		SHELL	JO	MIKE	SIMON
MIKE	MARK	STACEY		HANNAH	JOE	DEBBIE	AMY
EMILY	KATHERINE	DAN		DEBBIE	SHEFF	SARAH	BARRY
LUKE	JAMES	GUY		SPAM	FREYA	MAIA	
SHERYL	LEILA	CLAIRE		MARLON	PAUL	EMMY	
JACK	CHRIS	OSCAR		HUW	BEA	CLIFFORD	
SADIE	LEANNE	LILY		DJANGO	ARLO	POPPY	
WILL	SAM	ANNIE		RICHARD	ROBIN		
CAROLINE	KANE	LISA		SHARON	IAN	BILLY	
BEN	CORMAC	TOM	SUZY	LESLEY	AMEE		
DODI	ROB	ROB		MANSFIELD	NATALIE		

THE MORNING AFTER
PRINT OUT – CUT OUT – GET OUT !

WE'RE OUT!

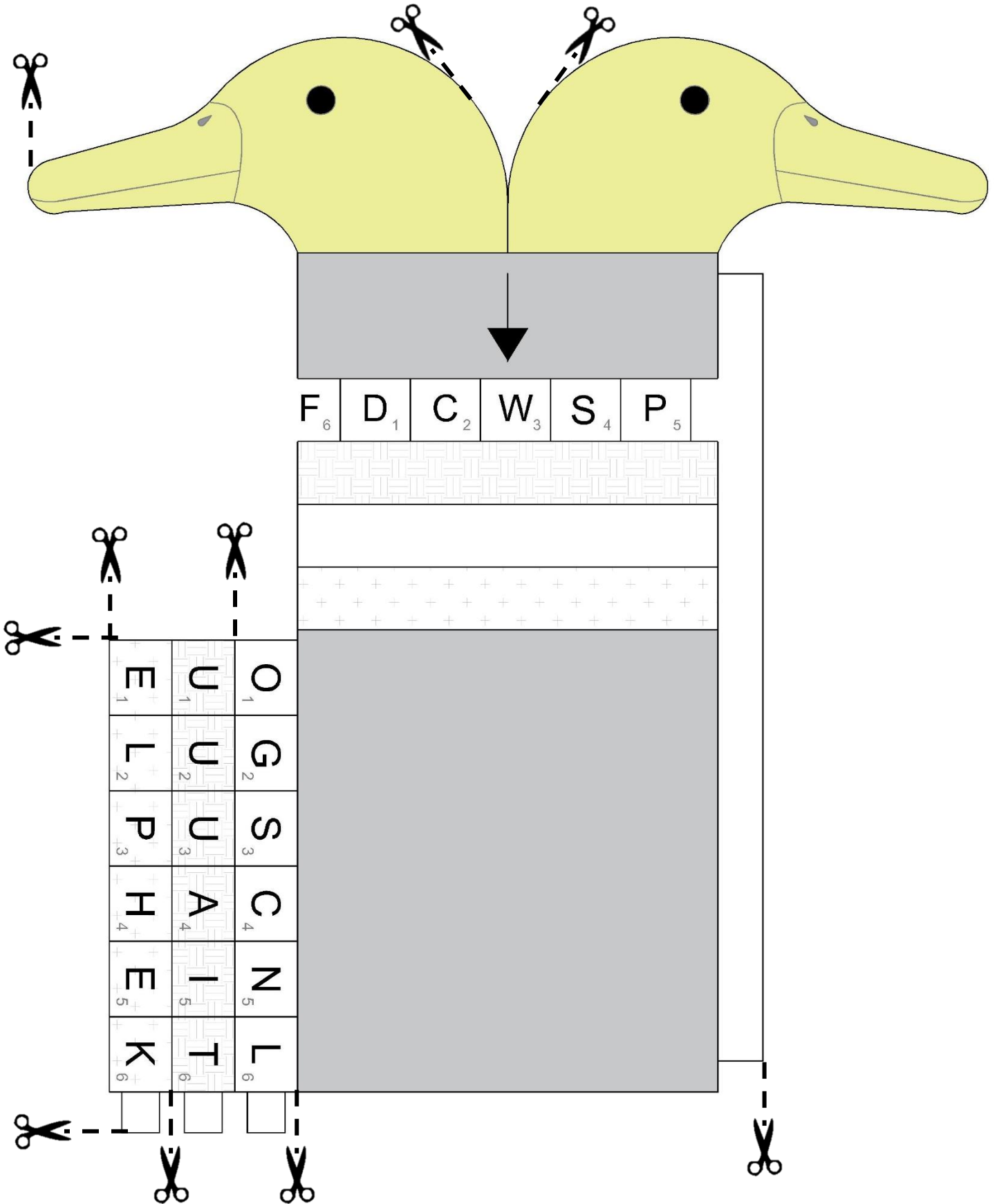

THE MORNING AFTER
PRINT OUT – CUT OUT – GET OUT !

I SHOULD FIX THE ELECTRICITY

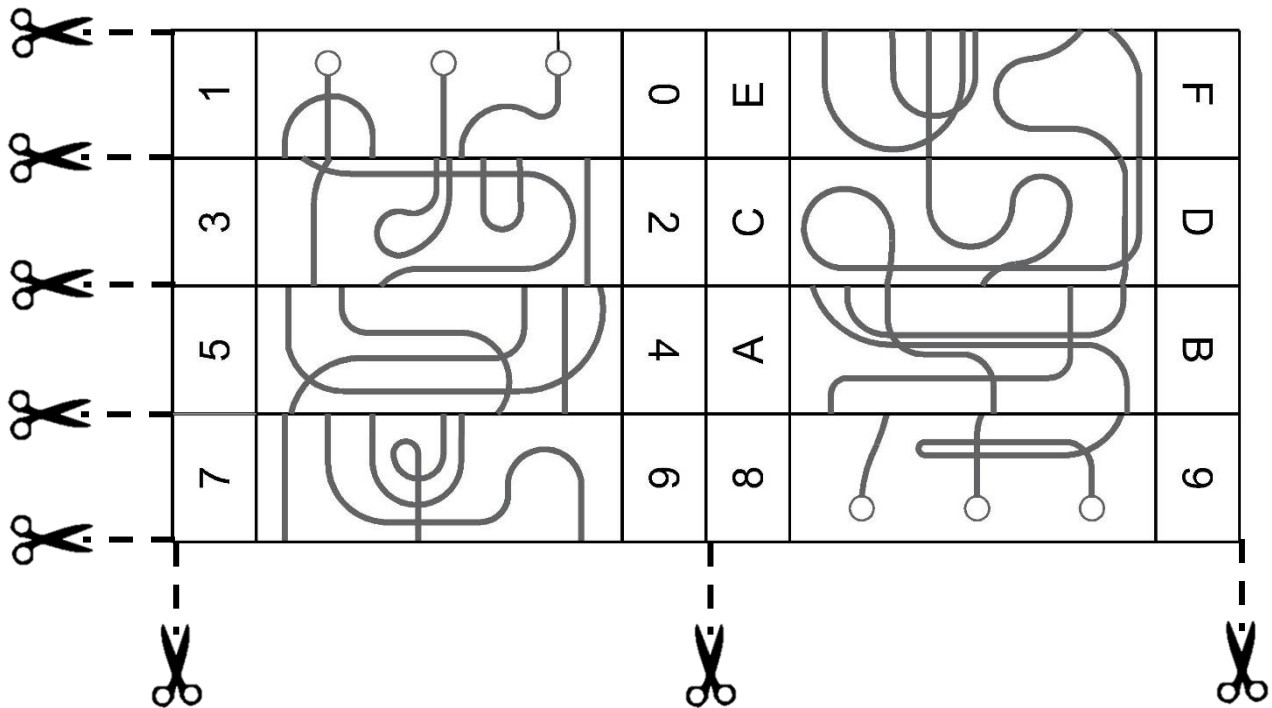
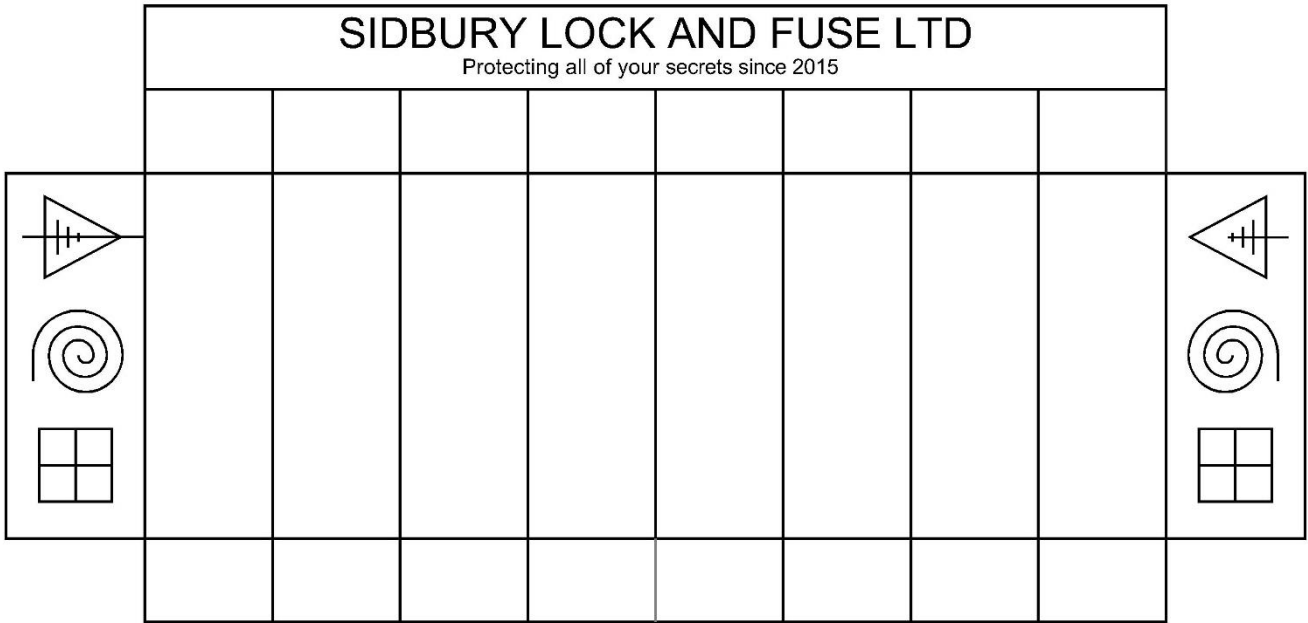

THE MORNING AFTER
PRINT OUT – CUT OUT – GET OUT !

FIXING THE MIRROR

